

Article number: 12710000160120

Description: KLEE-coil 710 000 160.120
M16 Unhardened, zinc-pl. & chr. yellow

Measures

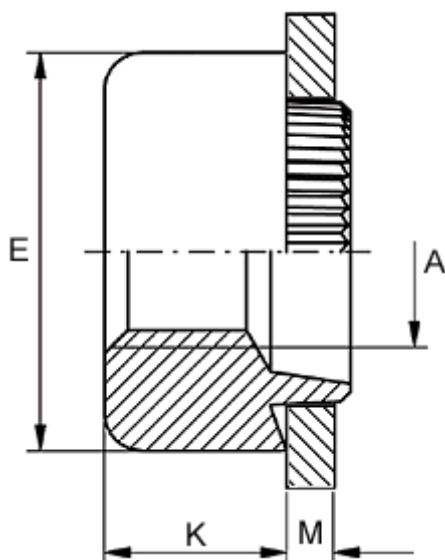

Female thread A	= M16
Height K	= 10.0
Outer diameter E	= 25.0
Plate thickness	= 2.6 to 2.8
Recommended bore diameter for extreme load	= 19.0
Recommended bore diameter for normal use	= 20.0